



**BEC 6500AEL**

**4G/LTE Enterprise  
Multi-Service Router**

**Quick Start Guide**





PLEASE READ THE QUICK START GUIDE AND FOLLOW THE STEPS CAREFULLY. THIS QUICK START GUIDE WILL HELP YOU INSTALL THE DEVICE PROPERLY AND AVOID IMPROPER USAGE. IF YOU NEED MORE INFORMATION ON THIS SOFTWARE CONFIGURATION, PLEASE REFER TO THE ONLINE USER MANUAL.

## Package Contents

- ✓ BEC 6500AEL 4G/LTE Wi-Fi Broadband Router x 1
- ✓ This Quick Start Guide x 1
- ✓ Wi-Fi Antenna x 2
- ✓ RJ-45 Ethernet Cable x 1
- ✓ DC Power Adapter 15V DC 1.6A x 1
- ✓ 4G/LTE Antenna x 2 (6500AEL R18/R21 is using four (4) 4G/LTE antennas)

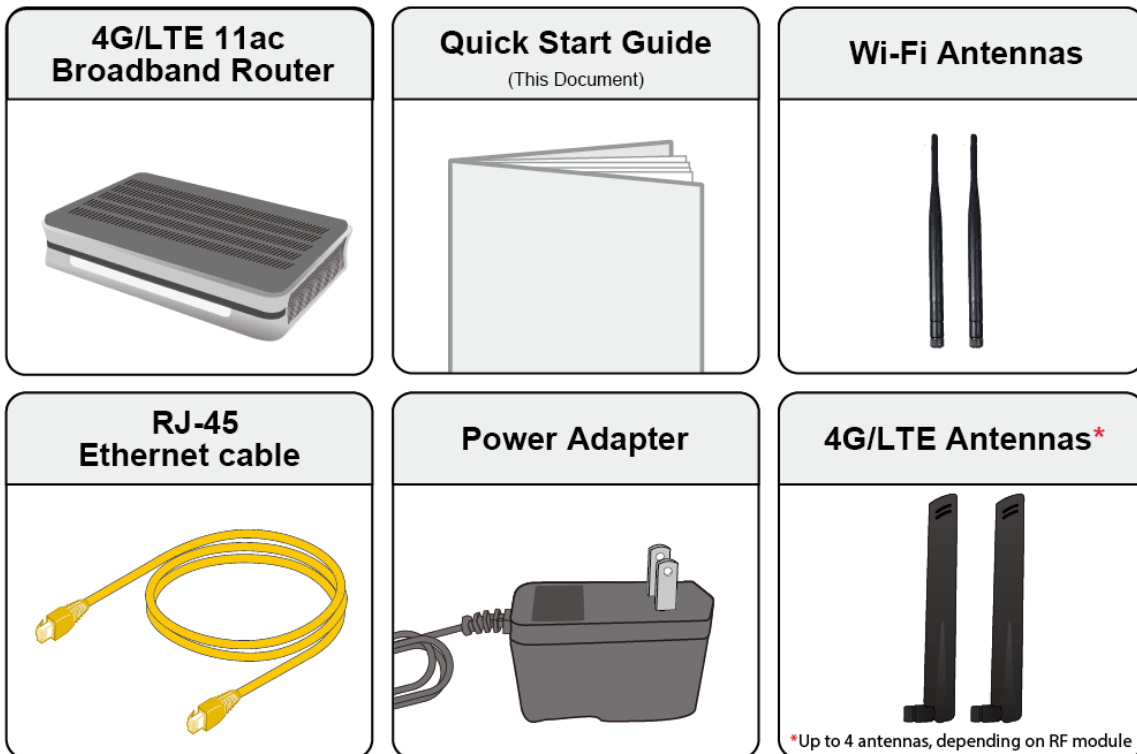

NOTE: ALL IMAGES SHOWN ARE FOR ILLUSTRATION PURPOSE ONLY.  
PACKAGE CONTENTS MAY DIFFER FROM ACTUAL PRODUCTS.



- Do not use the router in high humidity or at high temperature.
- Do not use the same power source for the router as other equipment.
- Do not open or repair the case yourself. If the router is too hot, turn off the power immediately and have it repaired at a qualified service center.
- Avoid using this product and all accessories outdoors.



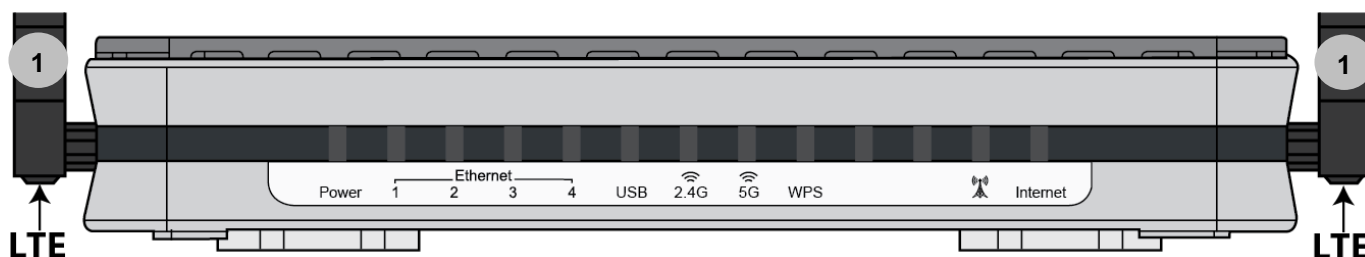

- Place the router on a stable surface.
- Only use the power adapter that comes with the package. Using a different voltage rating power adapter may damage the router.

## Front Panel - LEDs / LTE Connectors





PORT		MEANING
1	LTE Antenna Connectors	Screw the supplied mobile LTE antennas onto the antenna connectors on both sides. (6500AEL R18 / R21 uses <u>4</u> LTE antennas and <u>2</u> Wi-Fi antennas)

LED	STATUS	DESCRIPTION
Power 	Green	System is up and ready
	Red	Boot failure
Ethernet Port LAN 1 - 4	Green	Transmission speed is at Gigabit speed (1000Mbps)
	Orange	Transmission speed is at 10/100Mbps
	Blinking	Data being transmitted/received
USB	Green	Connecting to hard drive for storage or file sharing, etc.
Wi-Fi 2.4G / 5G 	Green	Wireless connection to 2.4G or 5G network is established
	Blinking	Data being transmitted / received
WPS	Green	Wireless device(s) being connected successfully via WPS mode
	Blinking	WPS is enabled and trying to establish a WPS connection
LTE (Received Signal Strength Indicator) 	Green	RSSI greater than -69 dBm. Excellent signal condition
	Green Flashing Quickly	RSSI from -81 to -69 dBm. Good signal condition
	Orange Flashing Quickly	RSSI from -99 to -81 dBm. Fair signal condition
	Orange Flashing Slowly	RSSI less than -99 dBm. Poor signal condition
	Orange	No signal and the 4G_LTE module is in service
	Off	No LTE module or LTE module fails
Internet	Green	WAN IP is received, and traffic is passing thru the device
	Red	Cannot get a WAN/public IP address
	Off	The device is either in bridged mode or WAN connection not ready.

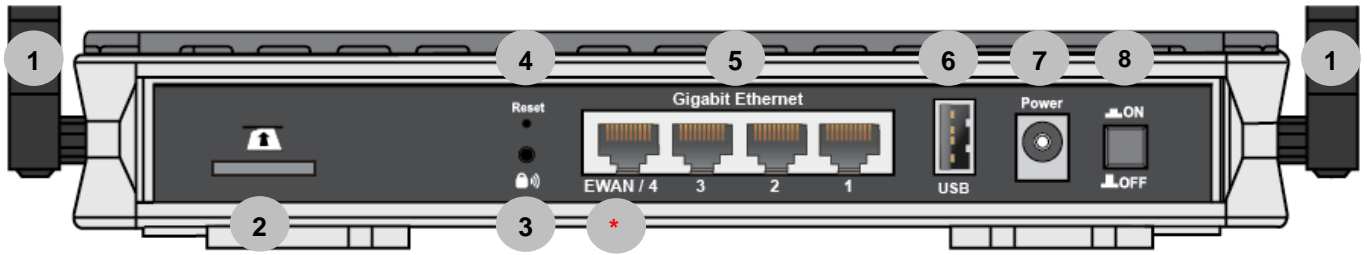
## Rear Panel – Ports / Connectors



PORT		MEANING
1	Wi-Fi Antenna Connectors	Screw the supplied Wi-Fi antennas onto the antenna connectors on both sides
1	LTE Antenna Connectors	(6500AEL R18 / R21 uses <b>4</b> LTE antennas and <b>2</b> Wi-Fi antennas) Screw the supplied mobile LTE antennas onto the antenna connectors on both sides
 2	SIM Card Slot	Insert the mini SIM card (2FF) with the gold contact facing down Push the mini SIM card (2FF) inwards to eject it
 3	WPS & Wireless On/Off	By controlling the pressing time, users can achieve two different effects: <b>(1) WPS*</b> : Press & hold the button for <b>less than 6 seconds</b> to trigger WPS function. <b>(2) Wireless ON/OFF button</b> : Press & hold the button for <b>more than 6 seconds</b> to enable or disable the wireless. <b>* Refer to the WPS section in the User Manual for more details.</b>
4	Reset	After the device is powered on, press it <b>6 seconds or above</b> : to restore to factory default settings (this is used when you cannot login to the router, e.g. forgot your password)
5	Gigabit LAN Ethernet (1 - 4)	Connect a UTP Ethernet cable (Cat-5 or Cat-5e) to one of the four LAN ports when connecting to a PC or an office/home network of 10Mbps /100Mbps /1000Mbps <b>* Ethernet WAN/4</b> Connect to Fiber/ Cable/ xDSL Modem with a RJ-45 cable, for broadband connectivity <b>Note: LAN 4 automatically becomes an ethernet WAN port when the ETH WAN internet interface is being selected in the GUI</b>
6	USB	Mainly for storage and file sharing
7	DC Power Jack	Connect the supplied Power Adapter to this jack
8	Power ON/OFF	Power ON/OFF switch

# Hardware Connection

## Back Panel Ports & Connectors

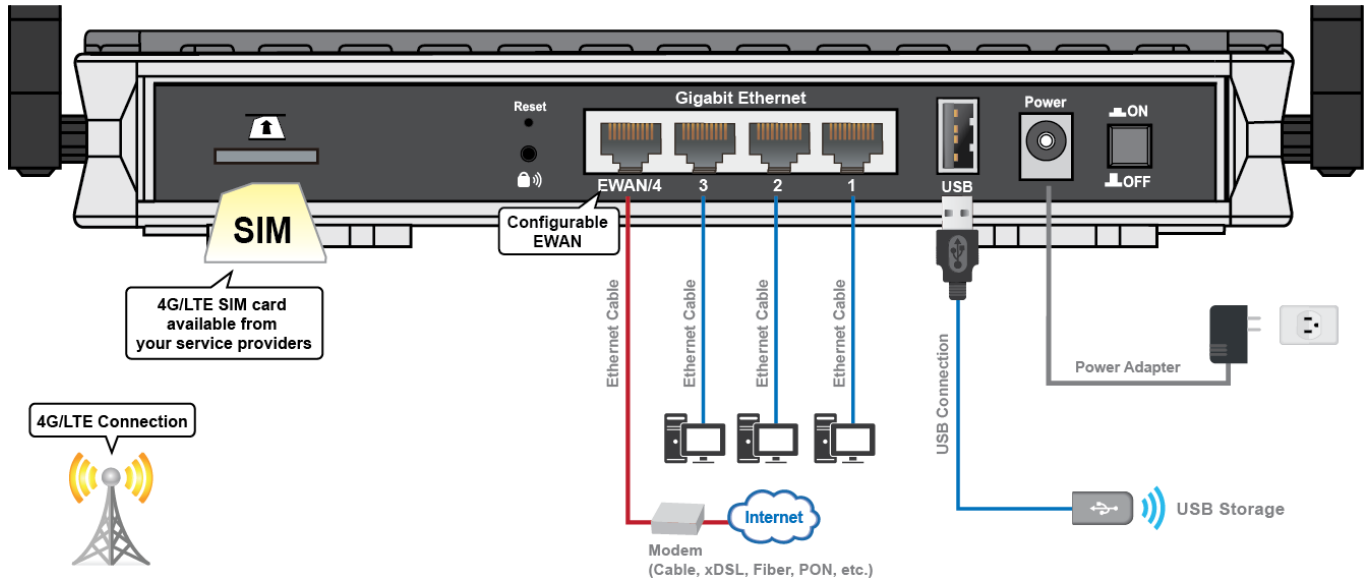

## Wi-Fi & LTE Antenna Connectors (Standard Version)

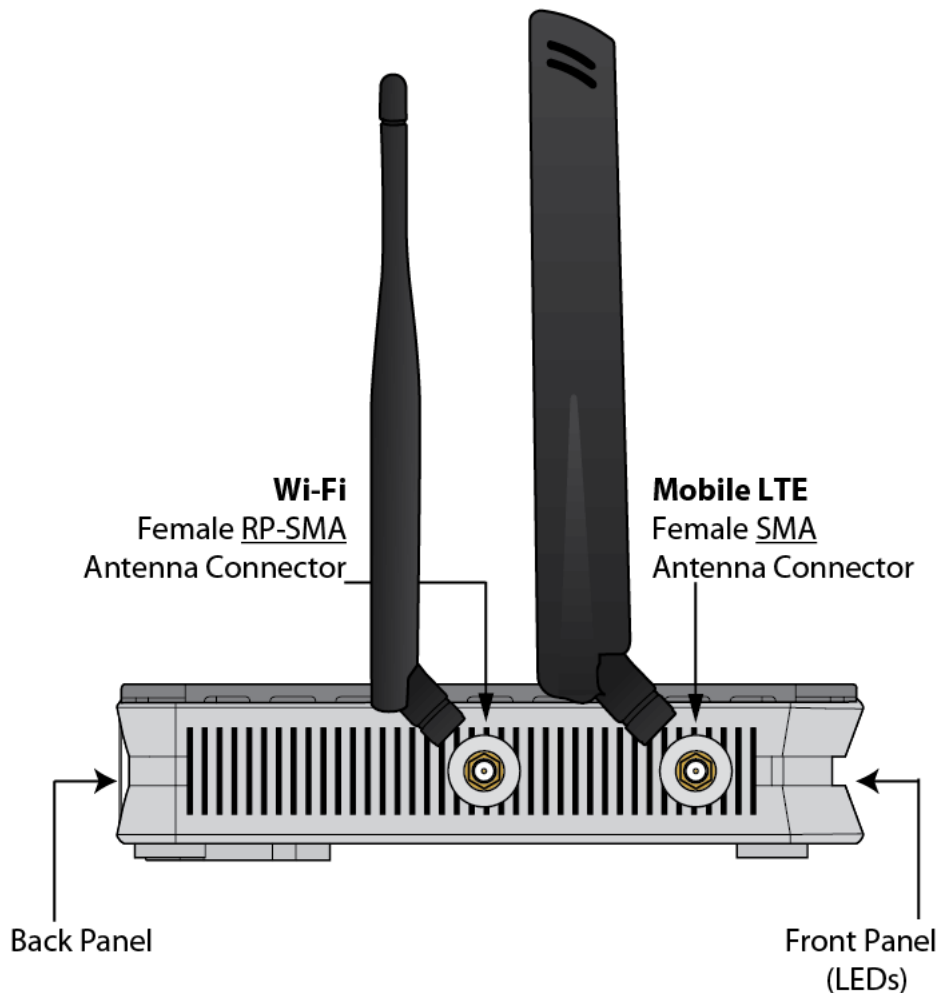

**Wi-Fi & LTE Antenna Connectors (6500AEL R18 / R21 Only)**

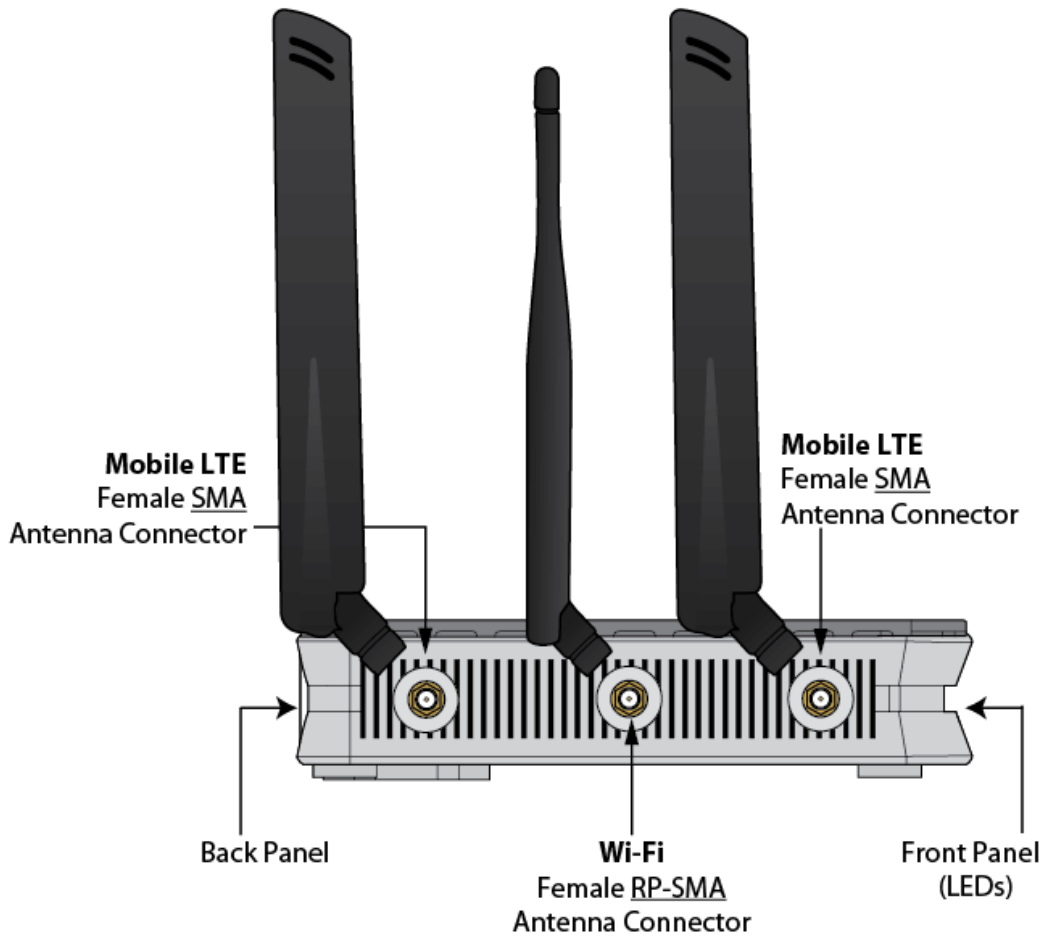

**Hardware Installation**

**1. Power Connection**

Plug in the supplied power adapter to the wall jack, the other side to device then power **ON** the 6500AEL by pressing the Power On/Off button.

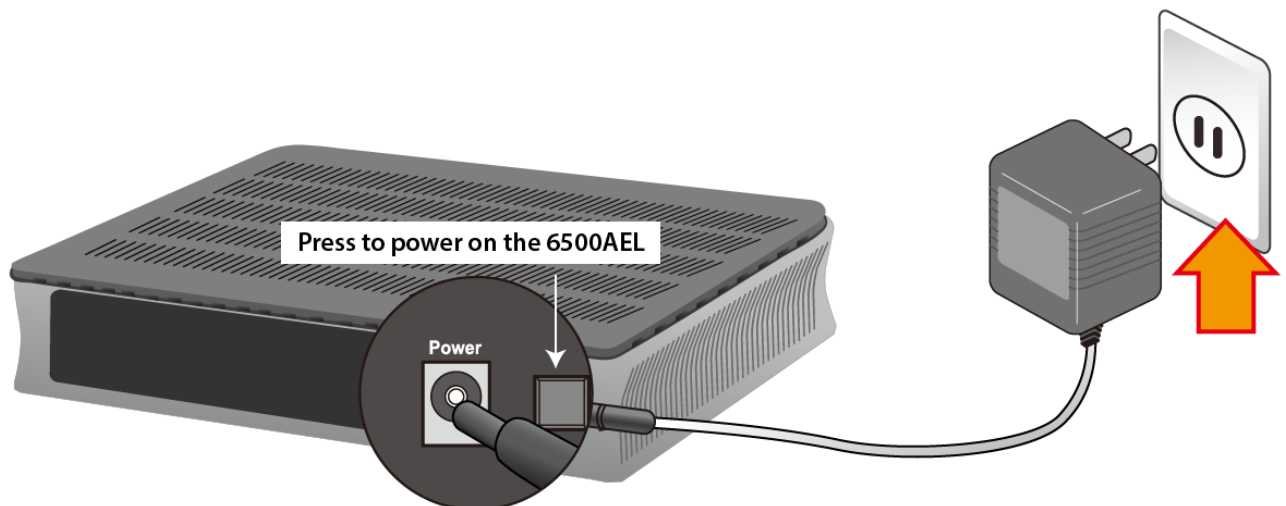

## 2. LAN Connection

Connect the supplied RJ-45 Ethernet cable to one of the Ethernet ports, and the other side to the PC's Ethernet interface.

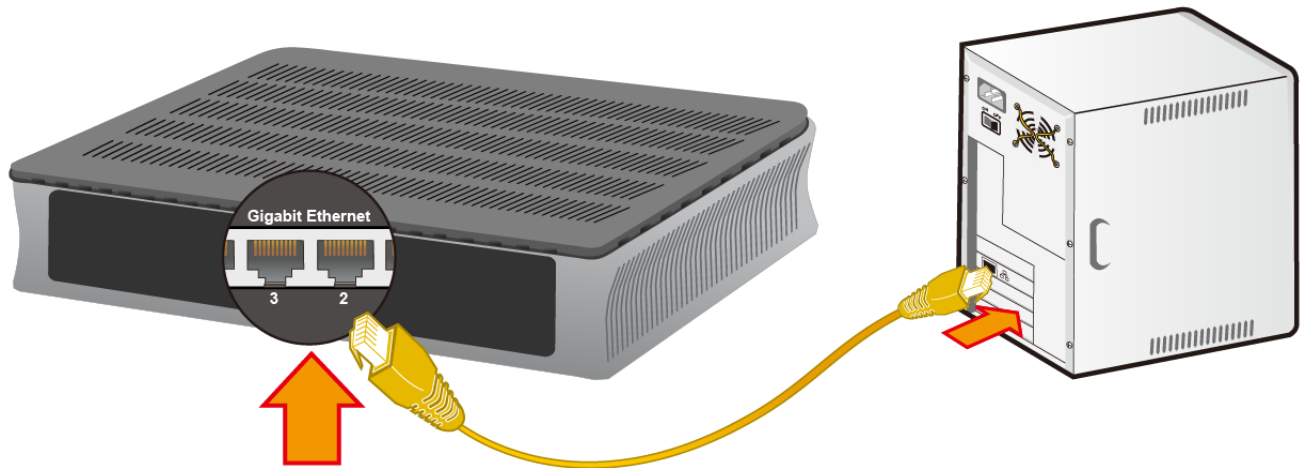

## 3. WAN Link Interface and Connection

BEC 6500AEL supports failover and failback on multiple WAN interfaces, 4G/LTE and Ethernet WAN <Please refer to User Manual for detailed Internet setup>

### 3.1 4G\_LTE Connection

Slide the SIM card into the card slot of the device with the gold contact facing down. Make sure that the SIM card has been slid into the bottom of the slot with a click. When removing the SIM card, press the SIM card again it will be ejected from the card slot.

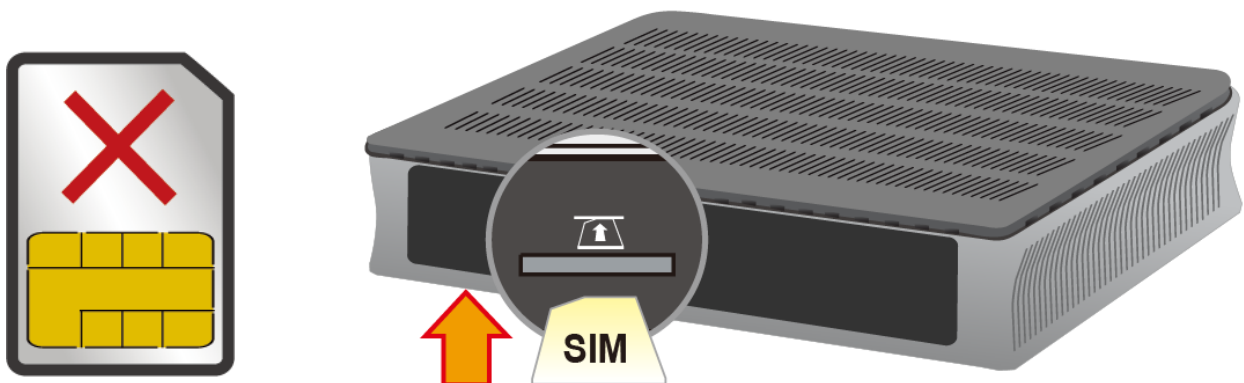

**WARNING: Please power off the device before inserting or removing the SIM**



### 3.2 Ethernet WAN Connection

Connect RJ-45 Ethernet cable to the **EWAN port**, and connect the other side to another alternative broadband device, such as Cable Modem, VDSL, Fiber Modem or PON optic lines.

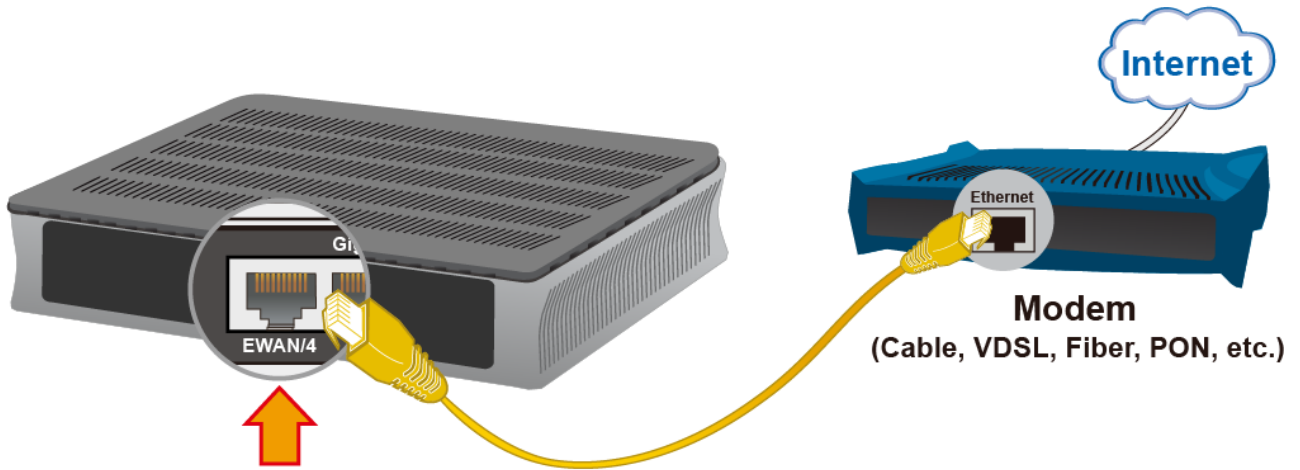

### 4. USB for Network File Sharing

BEC 6500AEL has built-in FTP and Samba Servers, simply plug in an external USB HD then follow the instruction setup in the User Guide.

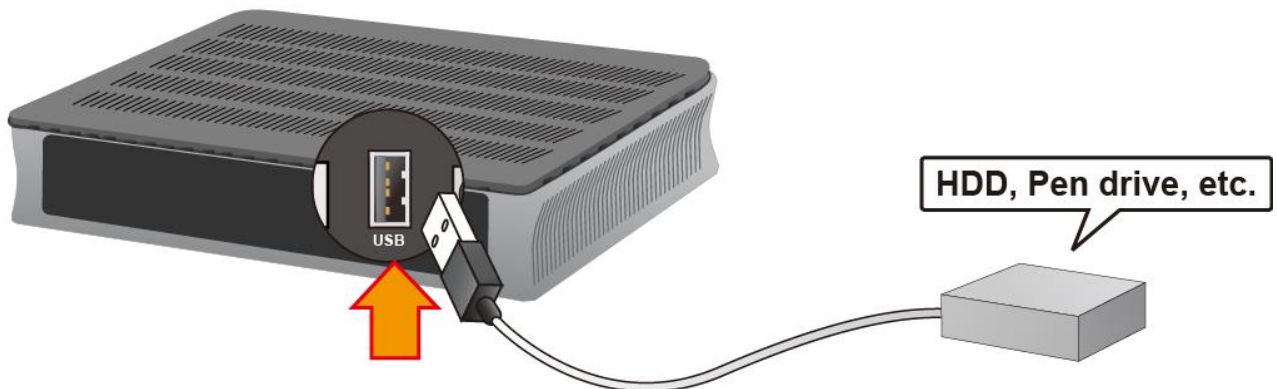

## Connecting to the Router

The default IP of modem is **192.168.0.1** with subnet 255.255.255.0. Make sure the attached PC to this router is in the same subnet and has an IP address in the range between 192.168.1.1 ~ 192.168.1.253.

Open a web browser and type **http://192.168.0.1** in the URL address bar.

URL Address bar: type  
**http://192.168.0.1**



The login prompt will appear. Input the default username (**admin**) and password (**admin**) for Account type, Administrator. \*This username / password may vary by different Internet Service Providers.

## Quick Setup Your Router

**Wired Broadband Connection - Before start configuring the 6500AEL, make sure you have the Ethernet WAN connected with your Internet box or fiber line.**

### Step 1: Change administration password

Setup a new password for “admin” account for device management. The default password is “admin”. Click Continue to go on to the next step.

\*The password may vary by different Internet Service Providers.

**New Password:** assign a new, **unique password**

**Confirm Password:** re-enter the new password again

**Next Step:** click **Next**

### Step 2: Time Zone configuration

Enable and select your Time Zone then click Continue to go on to the next step.

**Time Zone:** select your **time zone**

**Next Step:** click **Next**

### Step 3: Setup Wireless Connection

**Access Point:** select **Activated**

**SSID:** Assign a **unique name**

**Channel:** pick from **1~11**

**Security Type:** select a mode

- **Disable (No security)**
- **WPA**
- **WPA2 (Most secure one)**
- **WPA / WPA2 (auto detect WPA mode with wireless clients)**
- **WEP (Less secure one)**

**Pre-Shared Key:** key for wireless authentication

- **WPA / WPA2 Share Key:** Assign a key between 8 ~ 63 characters.
- **WEP:** select **Open System**, use default WEP Key 1 then assign **26 Hex codes**

**Next Step:** click **Next**

**Quick Start - Wireless**

Configure your wireless network, authentication type and click NEX

Access Point	<input checked="" type="radio"/> Activated <input type="radio"/> Deactivated
SSID	<input type="text" value="BEC345"/>
Broadcast SSID	<input checked="" type="radio"/> Yes <input type="radio"/> No
Channel	UNITED STATES <input type="text" value="11"/>
Security Type	Mixed WPA2/WPA-PSK
WPA Algorithms	AES
Pre-Shared Key	<input type="text" value="1234567890"/>
Key Renewal Interval	<input type="text" value="600"/> seconds (10 ~ 4194303)

Back Next

### Step 4: WAN / Internet Connection Setup

Select the 3G/4G-LTE mode in WAN Interface then click 'Next'.

**Quick Start - ISP Connection Type**

Dynamic IP Address

WAN Interface

Back Next

**Enter the following:**

- **TEL No.** Not required
- **APN ssi991.ssimicro.com**
- **Username** Not required
- **Password** Not required
- **PIN** Not required

**Net Step:** click **Next**

**Quick Start - 3G/4G-LTE**

Enter the 3G information provided to you by your ISP. Click **NEXT** to continue.

TEL No.	<input type="text" value="*99***1#"/>
APN	<input type="text" value="ssi991.ssimicro.com"/>
Username	<input type="text"/>
Password	<input type="text"/>
PIN	<input type="text"/>

Back Next

### Step 5: Save Confirmation Settings

Click "Next" to save and complete the Quick Setup. You should now be able to access to the Internet.

Please see the relevant sections of User Manual for detailed information.

---

---

## Troubleshooting

### 1. None of the LEDs are on when you turn on the router.

Check the connection between the adapter and the router. If the error persists, you may have a hardware problem. In this case you should contact technical support.

### 2. You have forgotten your router login and/or password.

Try the default login and password, please refer to User Manual. If this fails, you can restore your router to its factory settings by holding the Reset button on the back of your router for 6 seconds or more.

### 3. Can't ping any PCs on the LAN.

Check the Ethernet LEDs on the front panel. The LED should be on for a port that has a PC connected. If it is off, check the cables between your router and the PC. Make sure you have uninstalled any software firewall for troubleshooting. Verify that the IP address and the subnet mask are consistent between the router and the workstations.

## Product Support and Contact Information

Most problems can be solved by referring to the **Troubleshooting** section in the User Manual. If you have other inquiries or need further technical support, please contact with your Internet Service Provider or visit us at [www.bectechnologies.net](http://www.bectechnologies.net).

## FCC Statement

This equipment has been tested and found to comply with the limits for a Class B digital device, pursuant to Part 15 of the FCC Rules. These limits are designed to provide reasonable protection against harmful interference in a residential installation. This equipment generates, uses, and can radiate radio frequency energy and, if not installed and used in accordance with the instructions, may cause harmful interference to radio communications. However, there is no guarantee that interference will not occur in a particular installation. If this equipment does cause harmful interference to radio or television reception, which can be determined by turning the equipment off and on, the user is encouraged to try to correct the interference by one or more of the following measures:

- ♦ Reorient or relocate the receiving antenna.
- ♦ Increase the separation between the equipment and receiver.
- ♦ Connect the equipment into an outlet on a circuit different from that to which the receiver is connected.
- ♦ Consult the dealer or an experienced radio/TV technician for help.

### FCC Caution:

This device complies with Part 15 of the FCC Rules. Operation is subject to the following two conditions:

- (1) This device may not cause harmful interference
- (2) This device must accept any interference received, including interference that may cause undesired operation.

Any changes or modifications not expressly approved by the party responsible for compliance could void the user's authority to operate this equipment. This device and its antenna(s) must not be co-located or operating in conjunction with any other antenna or transmitter.